

# FREEDOM UP/DOWN

## WXP80 - EXTERNAL WALL MOUNT PILLAR LIGHT



The Freedom wall mounted pillar light has a simple, minimalist design, which looks great on any style of building. It blends in seamlessly with both modern and heritage styles, without compromising quality or durability.

Constructed from both cast and extruded aluminium segments. Semi-matte aluminium reflector. Quality gasket and silicone seal to achieve IP65 ingress protection.

### PRODUCT SPECIFICATIONS

<b>Wattage:</b>	30W
<b>Lumens:</b>	~2400Lm
<b>CCT:</b>	3000K   4000K
<b>CRI:</b>	Ra>90
<b>Beam Angle:</b>	Any combo of: 15° 24° 36° 50°
<b>Material:</b>	Aluminium
<b>Reflector:</b>	Aluminium
<b>Colour:</b>	Black White
<b>IP Rating:</b>	IP65
<b>IK Rating:</b>	IK06
<b>Mounting:</b>	Surface (Wall)
<b>Lifetime:</b>	L80B10>60,000hrs

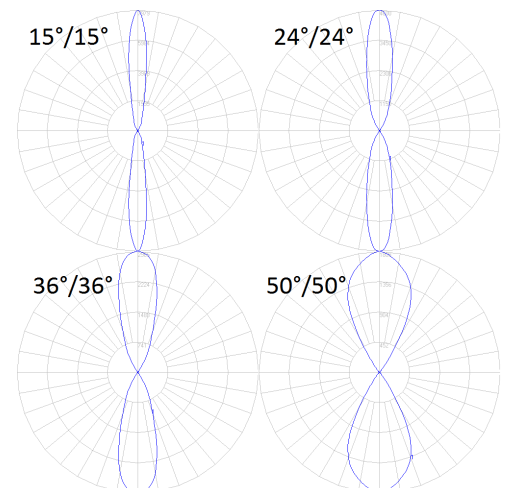

# FREEDOM UP/DOWN

## WXP80 - EXTERNAL WALL MOUNT PILLAR LIGHT

### CODING MATRIX

Family	Power		CCT		Trim Colour		Beam angle Down		Beam angle Up		
WXP80 <i>Up/Down</i>	-30	30W	2400Lm	-3K	3000K	-BK	Black	-15D	15°	15	15°
				-4K	4000K	-WT	White	-24D	24°	24	24°
								-36D	36°	36	36°
								-50D	50°	50	50°

### DIMENSIONAL DIAGRAM

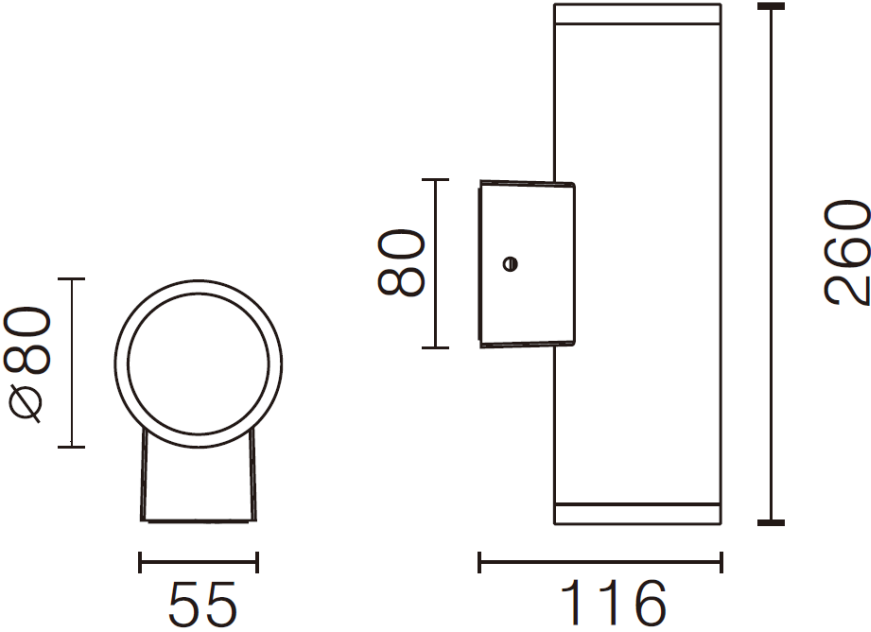

# FREEDOM UP/DOWN

## WXP80 - EXTERNAL WALL MOUNT PILLAR LIGHT

### INSTALLATION GUIDE

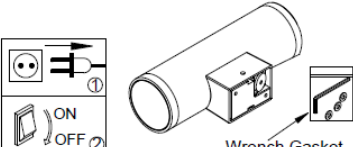
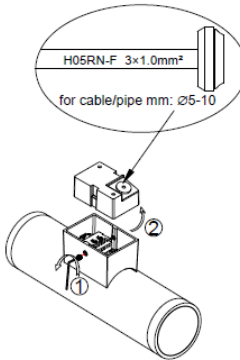
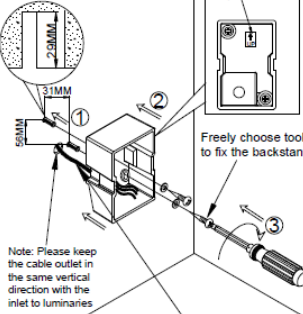
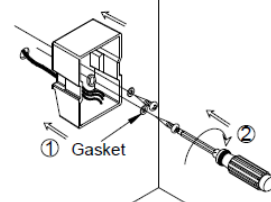
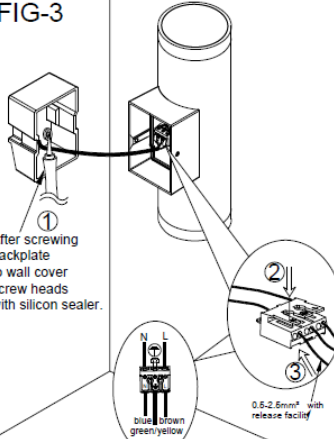
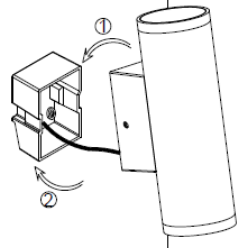
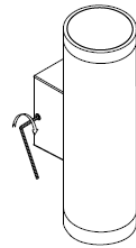
<p><b>WXP80</b></p> <p>If the external flexible cable or cord of this luminaire is damaged, it shall be exclusively replaced by the manufacturer or his service agent or a similar qualified person in order to avoid a hazard.</p> <p>The light source of this luminaire is not replaceable; when the light source reaches its end of life the whole luminaire shall be replaced</p>  <p>Wrench, Gasket</p>	<p><b>FIG-1</b></p> 	<p><b>FIG-2-A Concrete</b></p>  <p>Note: Please keep the cable outlet in the same vertical direction with the inlet to luminaires</p> <p>Note: In order to reach the required IP, the input cable for the luminaires must be H05RN-F 3x1.0mm², and threading through before stripping.</p>	<p><b>FIG-2-B Wood board</b></p> <p>Please make sure the thickness of the wood board no less than 5mm</p>  <p>① Gasket</p>
<p><b>FIG-3</b></p>  <p>After screwing backplate to wall cover screw heads with silicon sealer.</p> <p>0.5-2.5mm² with release facility</p> <p>blue brown green-yellow</p>	<p><b>FIG-4</b></p> 	<p><b>FIG-5</b></p> 	<p><b>FIG-6</b></p> 